

力旺電子 Briefing ■

ememory

IPR Notice ■

All rights, titles and interests contained in this information, texts, images, figures, tables or other files herein, including, but not limited to, its ownership and the intellectual property rights, are reserved to eMemory Technology Incorporated and PUFsecurity Corporation. This information may contain privileged and confidential information. Any and all information provided herein shall not be disclosed, copied, distributed, reproduced or used in whole or in part without prior written permission of eMemory Technology Incorporated or PUFsecurity Corporation.

eMemory: Embedded NVM with Logic Process

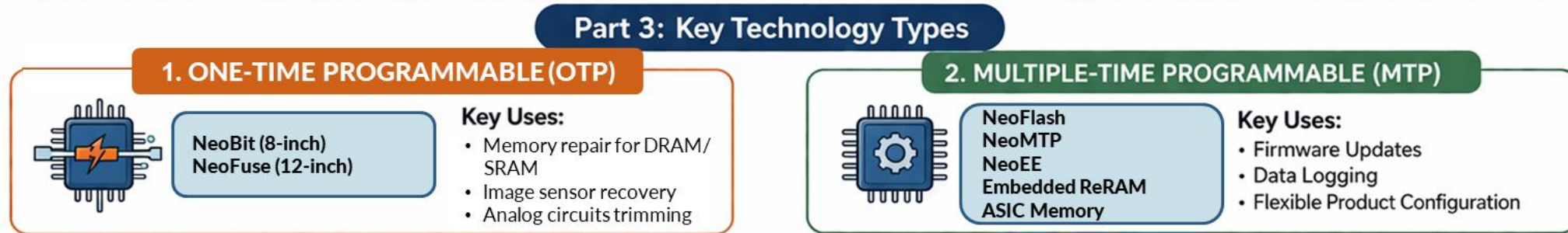
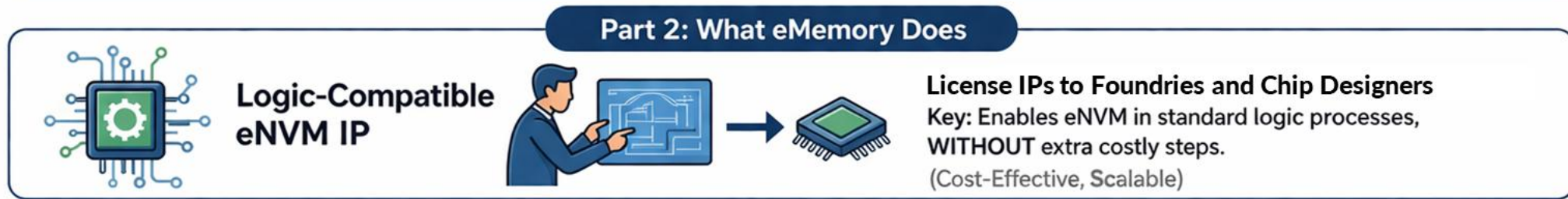
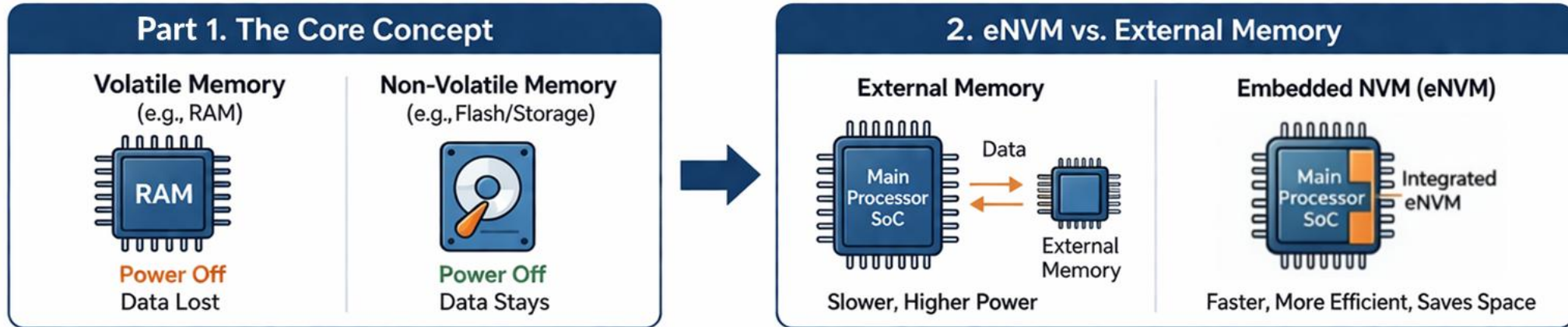

Company Overview

- eMemory leads the global market in **Logic NVM** and **PUF-Based Security IPs**.

Revenue Trend
(Unit: NT\$ in Million)

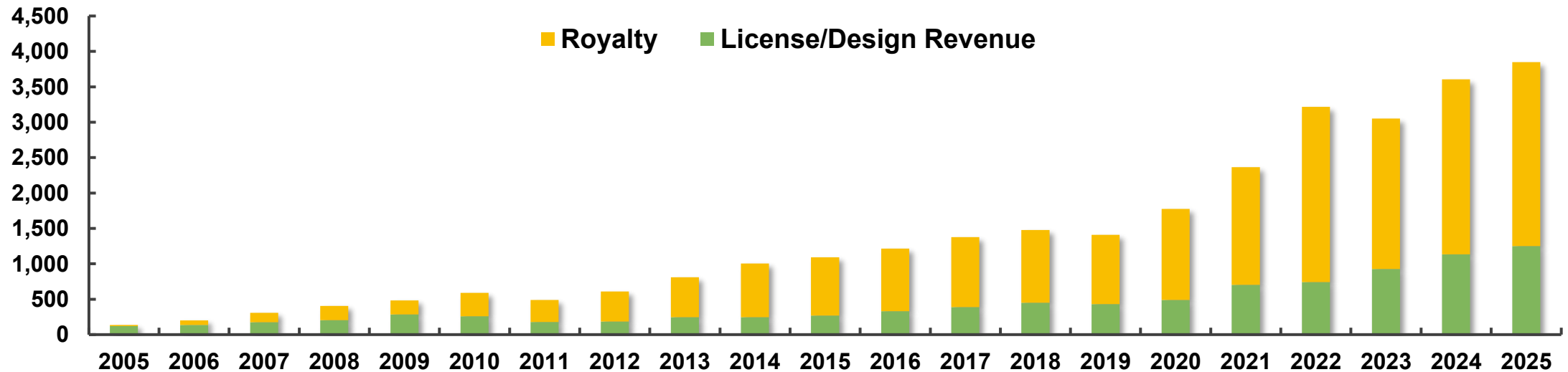

74M+

Cumulative Wafers Shipped

Spanning 740 production processes from 0.5 μ m to 2nm, and 9.8M wafers (8"-equivalent) shipped in 2025.

1350+

Patents Issued

Expanding our IP footprint with 228 pending patents, driven by a 342-member team with 73% R&D focus.

16-Year

Best IP Partner with TSMC

Founded in 2000 and IPO in 2011. Recognized as TSMC's Best IP Partner every year since 2010.

Technology Portfolio

- eMemory's IP portfolio is built on two pillars: **OTP** as the foundation and **MTP** for scalable integration.

PUFsecurity

Pioneering PUF-Based Security IP Design

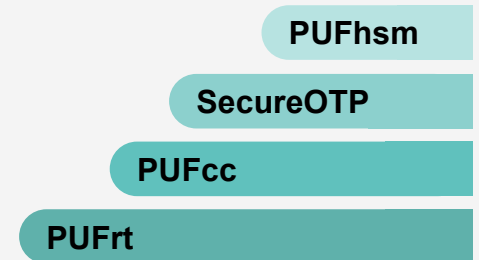

eMemory

Leading NVM and PUF Technology Innovation

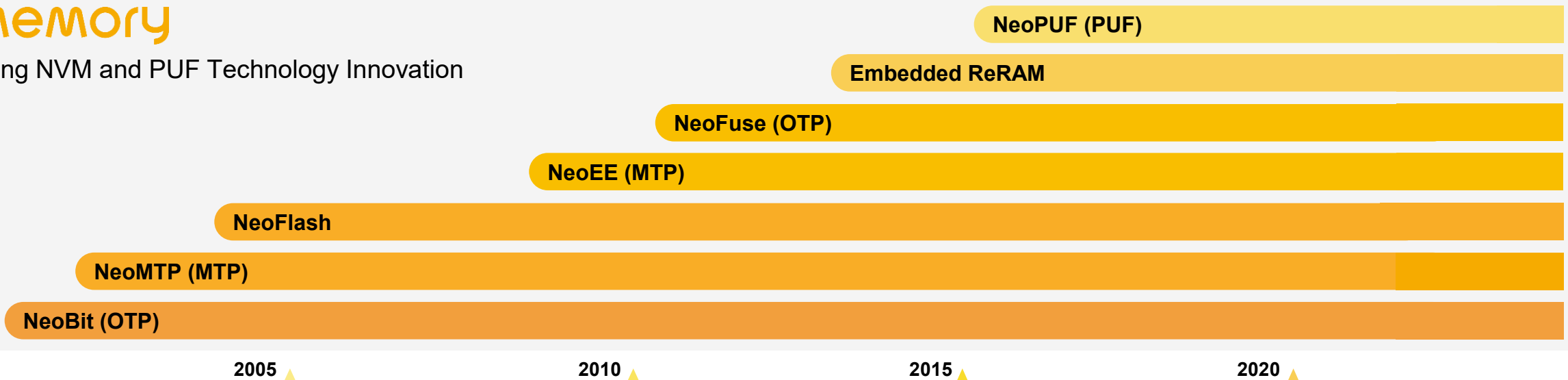

2005

2010

2015

2020

One-Time Programmable (OTP) Memory

- eMemory advances silicon security from foundational OTP to next-gen NeoPUF-Based solutions.

From OTP to PUF



- NeoBit (8" Wafer Processes)
- NeoFuse (12" Wafer Processes)

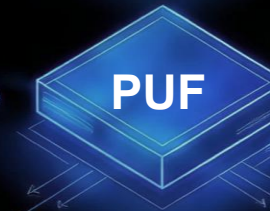

- NeoPUF
- PUFrt
- SecureOTP



- PUFcc
- PUFhsm



- RSA
- ECC
- AES
- SHA
- PQC
- etc.

Yield Enhancement

- Memory repair for DRAM/SRAM
- Image sensor recovery
- Analog circuits trimming

Fundamental Security

- Hardware root-of-trust
- Unalterable key storage
- Silicon-level identity protection

Evolution from OTP to PUF-HSM

- eMemory evolves from OTP technology into integrated **PUF-based security subsystem**.

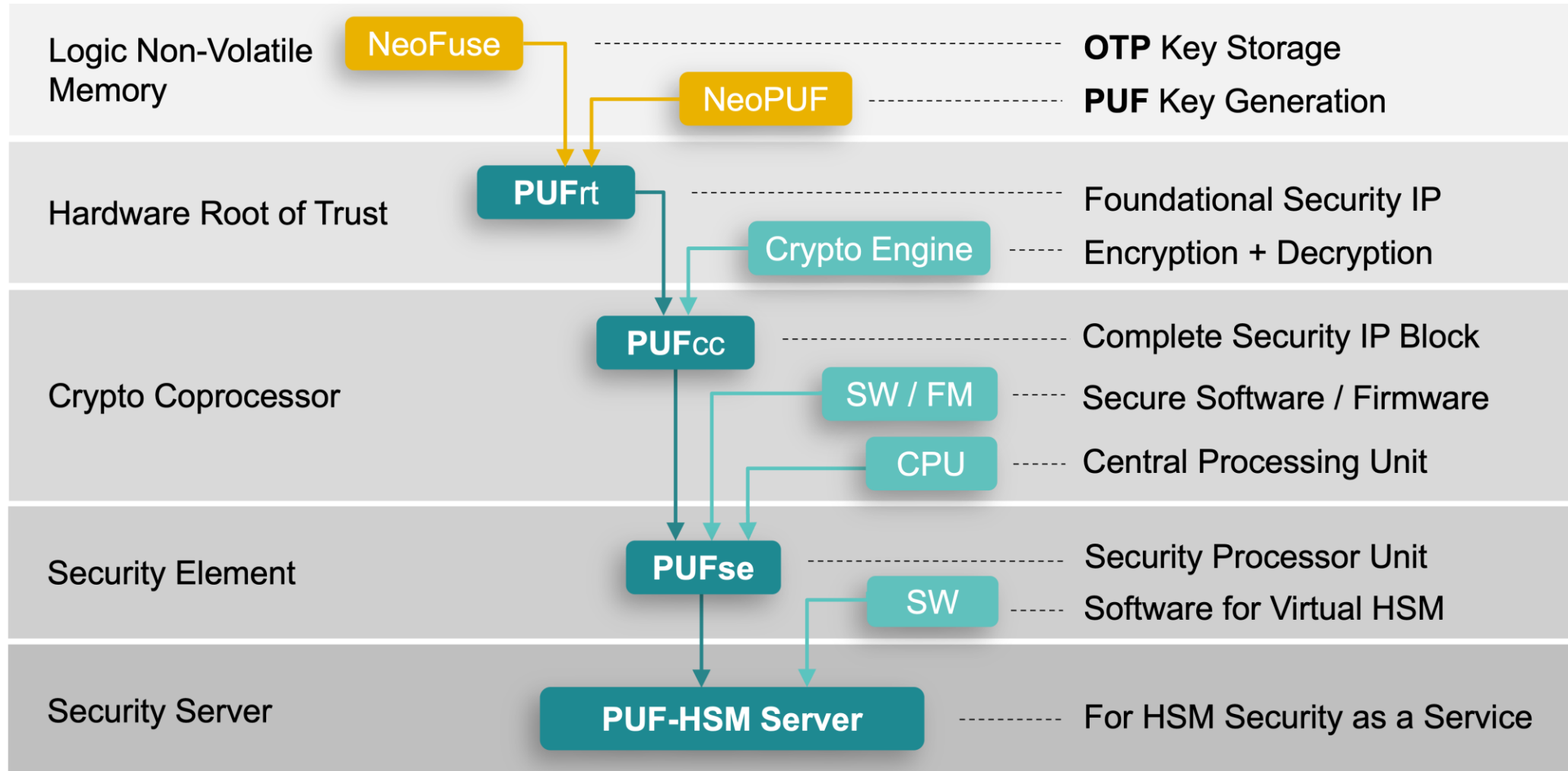

Multiple-Time Programmable (MTP) Memory

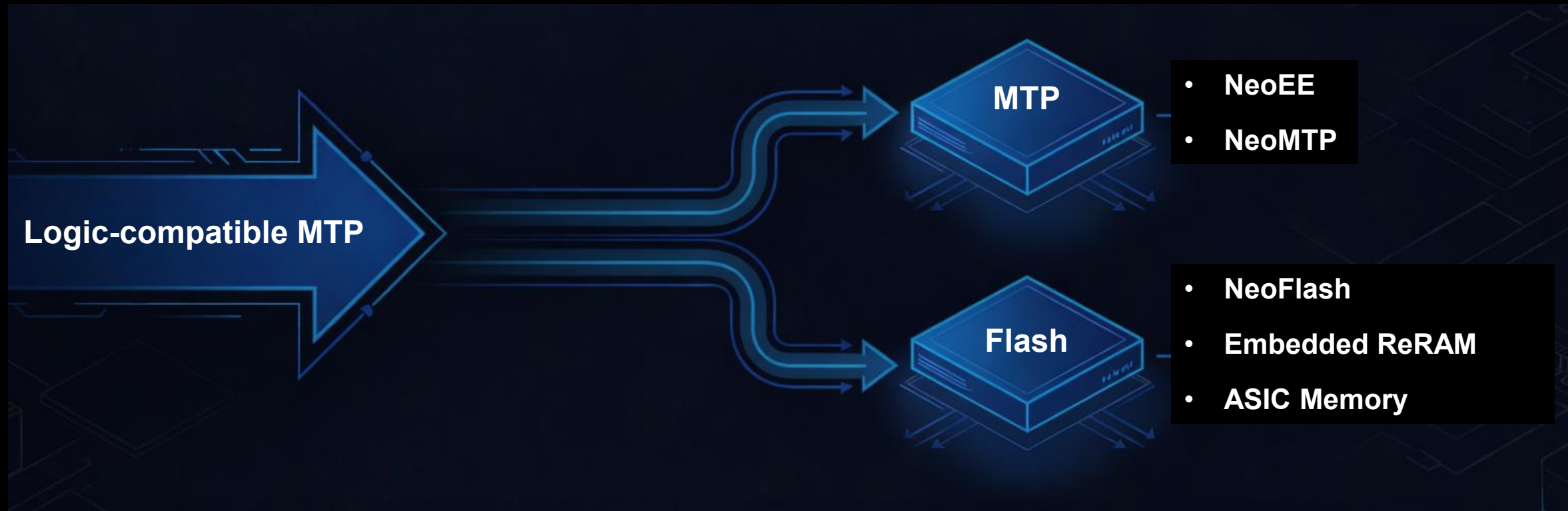

Density Variety

- Scalable storage configurations
- Optimized silicon footprint
- Versatile capacity range (Bits to Mb)

High Endurance

- Optimized write/erase cycles
- Enhanced data retention reliability
- Extended application operational lifespan

Process Integration

- Seamless standard logic embedding
- Foundry-ready ASIC integration
- Zero-mask overhead implementation

eMemory Enabling AI Memory Systems

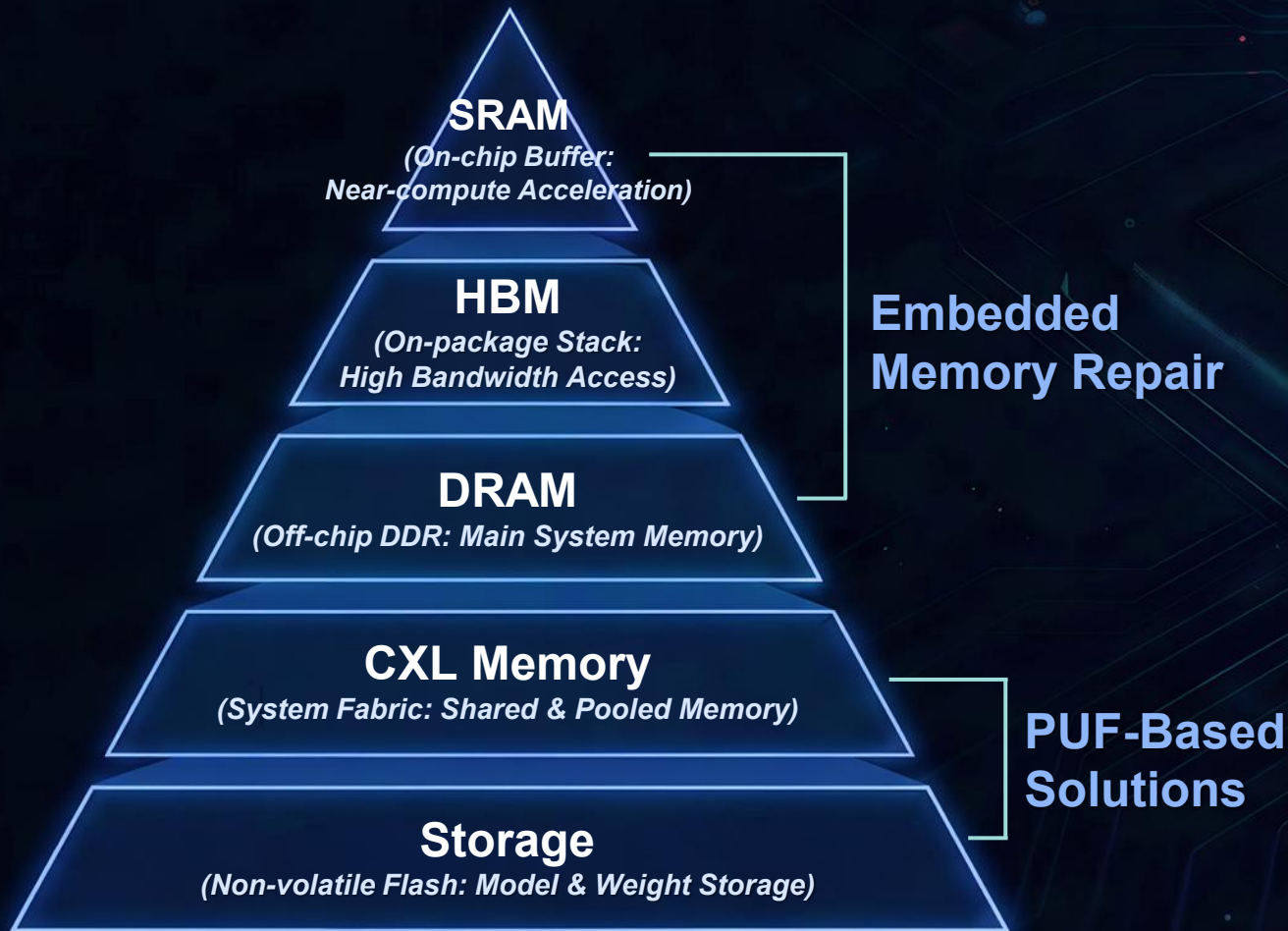

High Yield, Low Cost

- **OTP Repair:** Enhances SRAM/HBM/DRAM production yield
- **MTP Configuration:** Optimizes updateable DDR5/SOCAMM DIMMs
- **Cost Reduction:** Enables cost-effective AI chip mass production



High Reliability

- **Repair Integration:** Ensures HBM stack and DRAM integrity
- **Data Retention:** Guarantees long-term stability via OTP redundancy
- **Workload Stability:** Supports operational uptime under extreme AI tasks



High Security

- **PUF-Based Root of Trust:** Establishes hardware-anchored trust foundation
- **Secure Transmission:** Protects data integrity across CXL memory pools
- **Storage Protection:** Safeguards AI models within NVMe/SSD controllers

Anti-Fuse OTP vs. e-Fuse

e-Fuse

Physically Visible: Vulnerable to Reverse Engineering

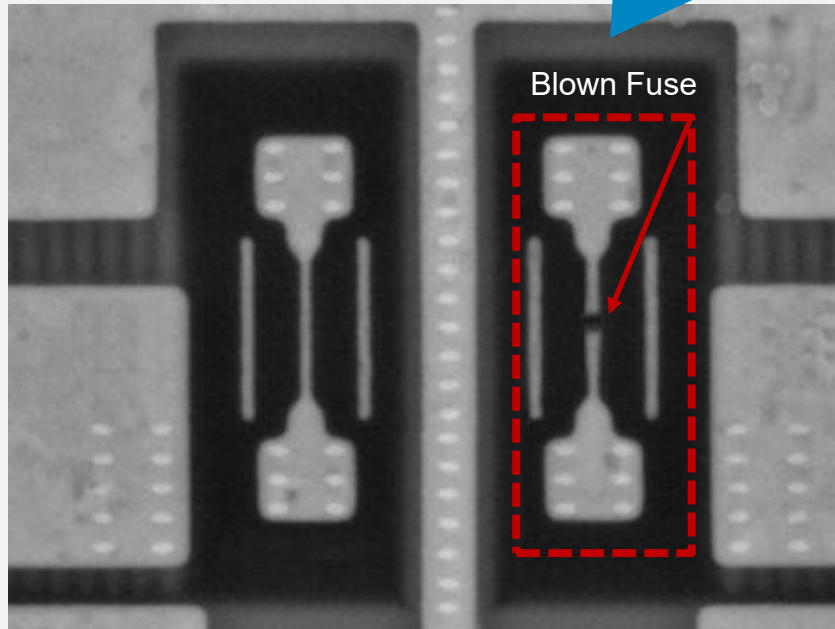

Anti-Fuse OTP (NeoFuse)

Physically Invisible: Resistant to Physical Attacks

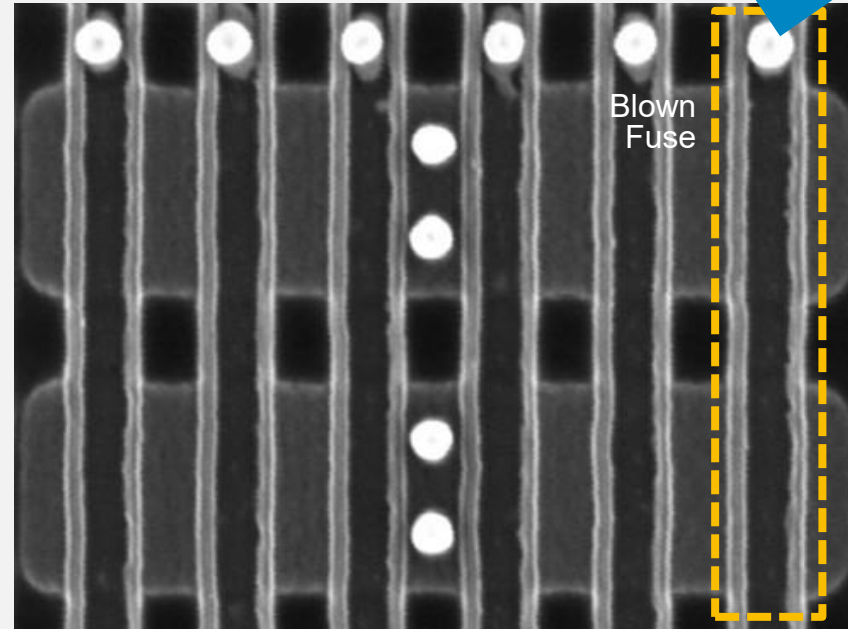

- Display Driver 
- PMIC 
- Sensor IC 
- Camera 
- MCU 
- Multi-Media 
- Automotive 
- RFID Tag 
- DRAM 
- Connectivity 



Arm RSS (Runtime Security Subsystem) Endorsement

- **Field-Programmable RSS Support:** Enables secure storage of confidential code and data within the Runtime Security Subsystem.
- **High-Density Efficiency:** Optimizes area for large arrays with seamless, low-overhead PUF integration.

e-Fuse Bottlenecks

Advanced-Node SoCs

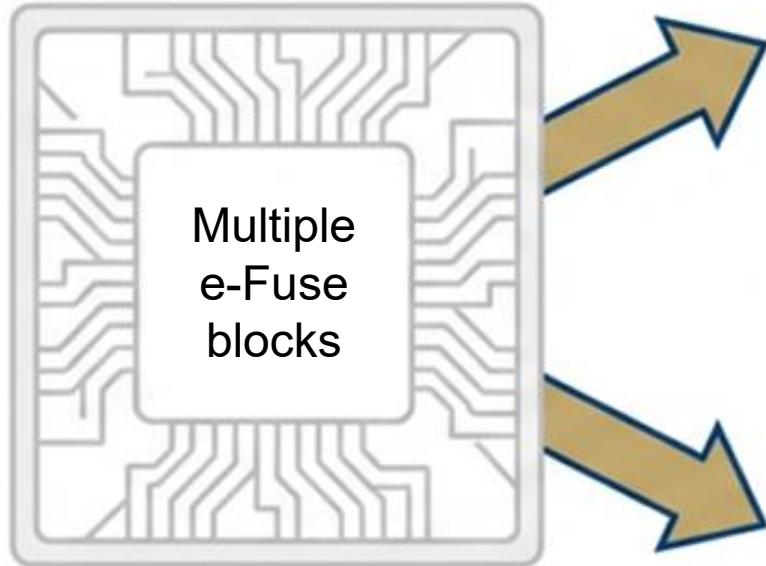

Area Overhead

Mandatory SRAM buffering **doubles the memory footprint** due to read limitations.



Design Complexity

Scattered multiple e-Fuse block layouts trigger **severe routing and power grid challenges**.

Diverse functional needs in advanced-node SoCs (e.g., ROM code, key storage) drive the mandatory use of multiple e-Fuse blocks.

OTP Area Efficiency

- eMemory's OTP outperforms e-Fuse in area efficiency **beyond 4K×8 densities.**

Example:
32K x 8 Density

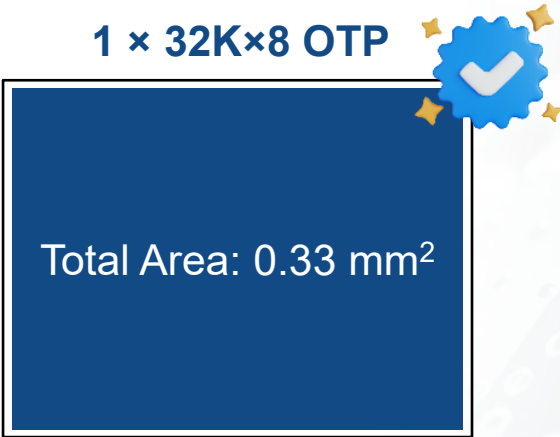
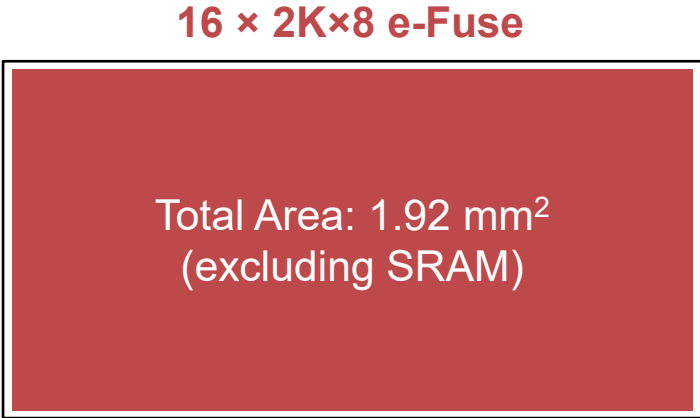

Item	e-Fuse Solution	OTP Solution	OTP Advantages
Number of Macros	16 Macros	1 Macro	Single-macro simplicity
Total Area	~1.92 mm ²	0.33 mm ²	>80% Area reduction
Additional SRAM	Required	Not required	Zero buffer SRAM requirement
Design Effort	High (Scattered)	Low (Centralized)	Simplified layout & routing

Registered IPs at TSMC

- eMemory integrates widely across TSMC process nodes with **over 850 registered IPs** to enable broad customer adoption.

IP Portfolio Trend
(Unit: # of IPs)

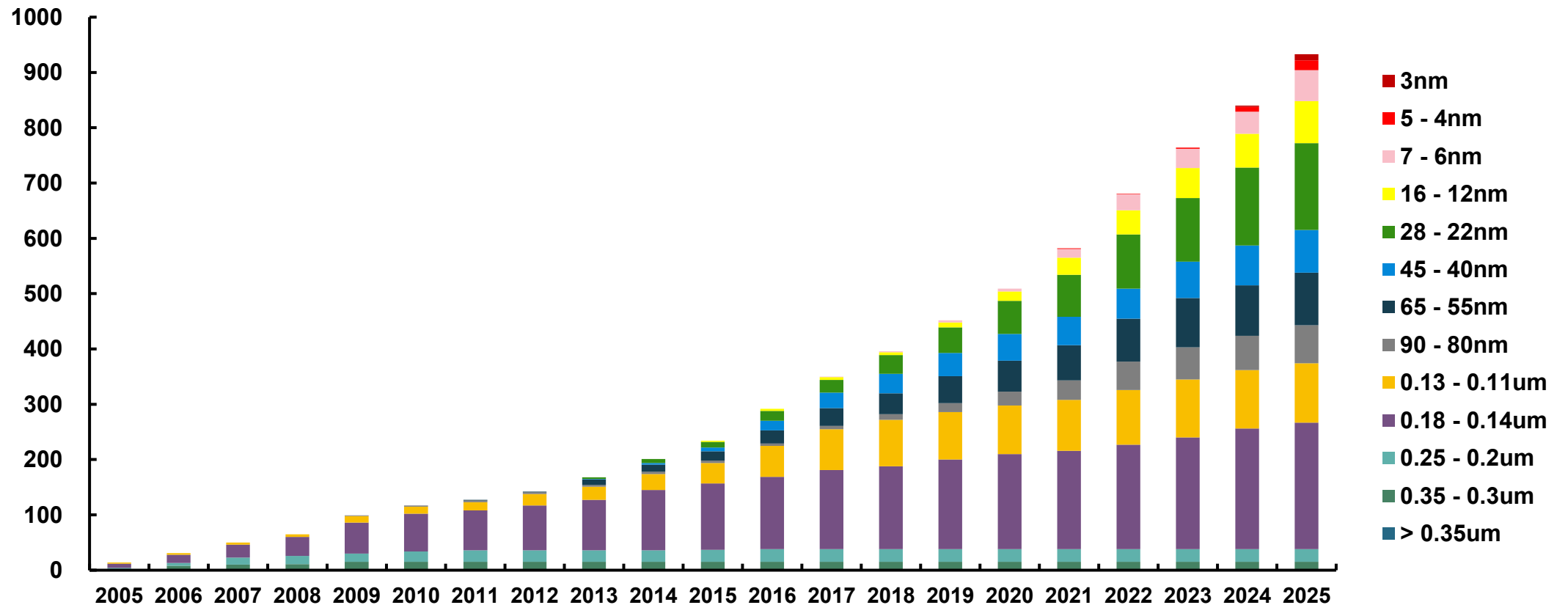

New Tape-Outs at TSMC

- eMemory secures continuous success with **over 2,600 new tape-outs (NTOs)** across all leading-edge and mature process nodes.

New Tape-out Trend
(Unit: # of tape-outs)

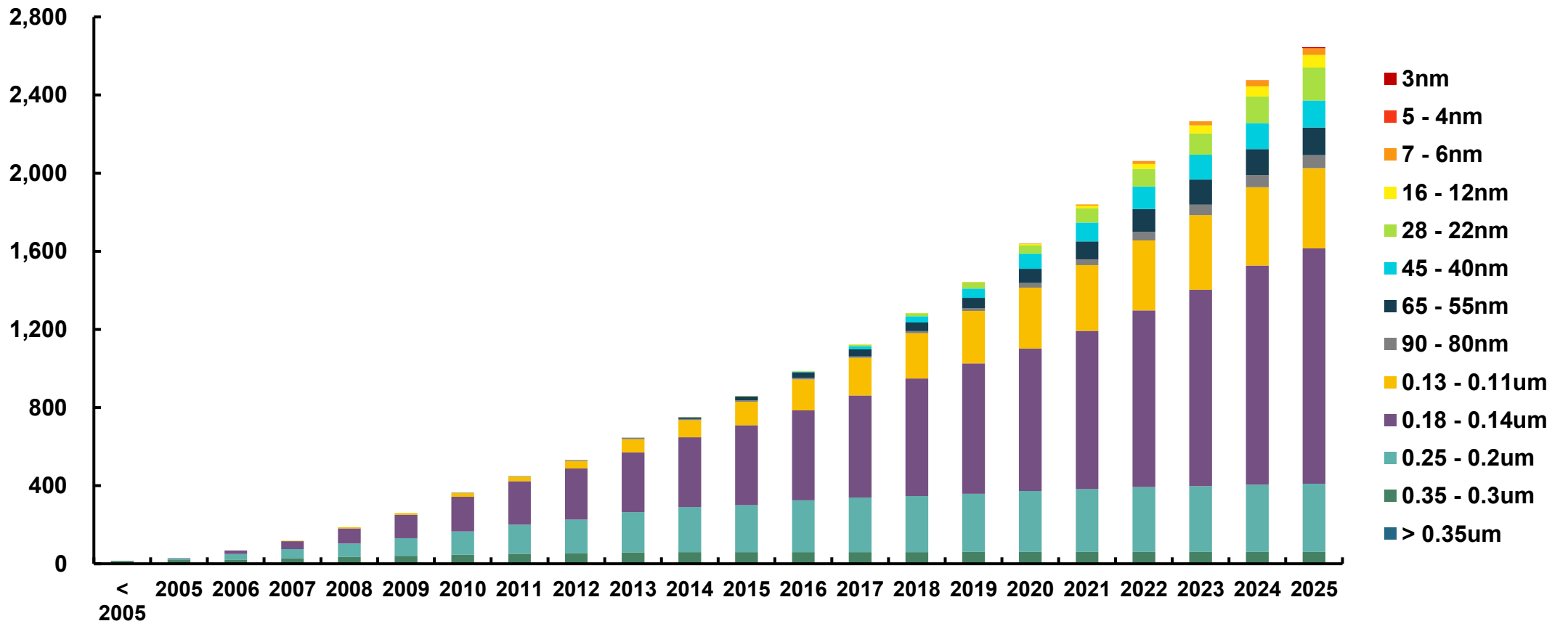

Wafer Shipment at TSMC

- eMemory translates **over 25M wafer shipments (8"-equivalent)** into recurring royalty revenue with long-term visibility.

Wafer Shipment Trend
(Unit: M Wafers)

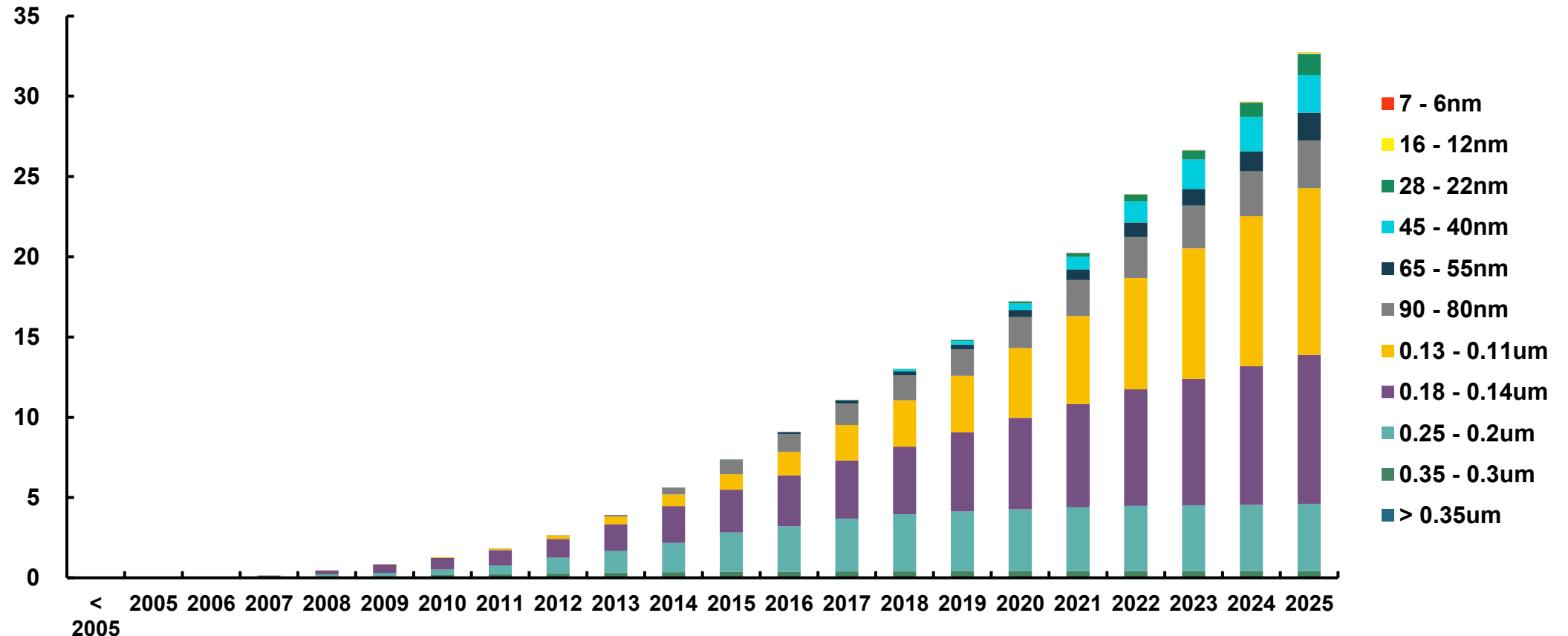

Accumulated Advanced-Node NTOs

- eMemory secures future growth with **140 accumulated advanced-node tape-outs**, building a high-value royalty pipeline driven by increasing adoption.

Leading-Edge Nodes (3nm–7nm)

59 TOTAL TAPE-OUTS

Driven primarily by AI and Advanced System-on-Chip (SoC) technologies.

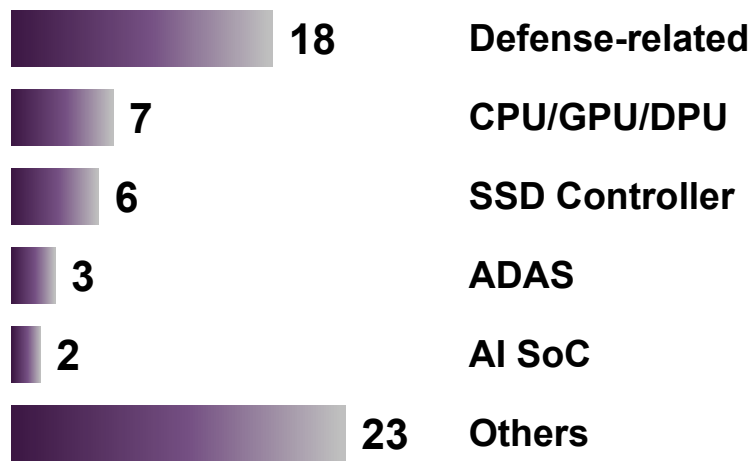

Mainstream Advanced Nodes (12nm/16nm)

81 TOTAL TAPE-OUTS

Driven by demand in High-end Multimedia Processing and Networking sectors.

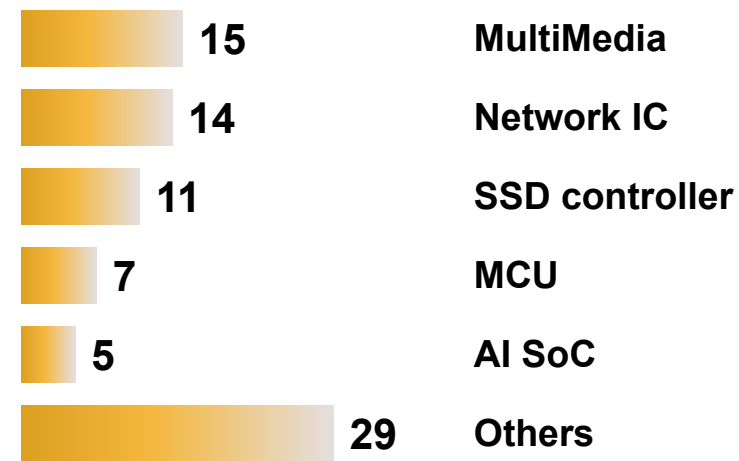

Tape-outs and Revenue by Technology

Year	NTO			Revenue (USD)		
	NeoBit	NeoFuse	PUF-Based	NeoBit	NeoFuse	PUF-Based
2002	3					
2003	29					
2004	40					
2005	68			\$ 4,217,380		
2006	133			\$ 6,202,270		
2007	220			\$ 9,402,479		
2008	253			\$ 12,896,211		
2009	268			\$ 11,695,587		
2010	284			\$ 15,873,331		
2011	254			\$ 15,399,098		
2012	270			\$ 19,620,768		
2013	363	1		\$ 25,436,669	\$ 382,084	
2014	371	3		\$ 31,831,985	\$ 328,787	
2015	311	11		\$ 30,943,426	\$ 1,080,373	
2016	270	28		\$ 30,247,340	\$ 3,636,142	
2017	257	61		\$ 34,619,653	\$ 5,238,351	
2018	253	86	1	\$ 31,834,860	\$ 10,773,223	\$ 85,000
2019	226	109	2	\$ 27,602,332	\$ 14,466,279	\$ 195,000
2020	248	182	3	\$ 30,378,346	\$ 26,437,660	\$ 434,998
2021	252	259	6	\$ 32,367,560	\$ 44,011,223	\$ 1,160,702
2022	264	231	33	\$ 35,327,060	\$ 63,762,480	\$ 4,207,348
2023	226	241	29	\$ 23,251,721	\$ 64,276,058	\$ 4,375,409
2024	266	270	32	\$ 25,952,137	\$ 71,649,123	\$ 5,279,985
2025	253	248	54	\$ 27,312,244	\$ 78,122,682	\$ 7,645,293
Total	5,382	1,730	160	\$ 482,412,457	\$ 384,164,465	\$ 23,383,735

*Revenue includes both **licensing** and **royalty**

Hardware Root of Trust (HRoT) ■

- eMemory provides the **foundational Hardware Root of Trust** that secures the entire software stack throughout the chip's lifespan.

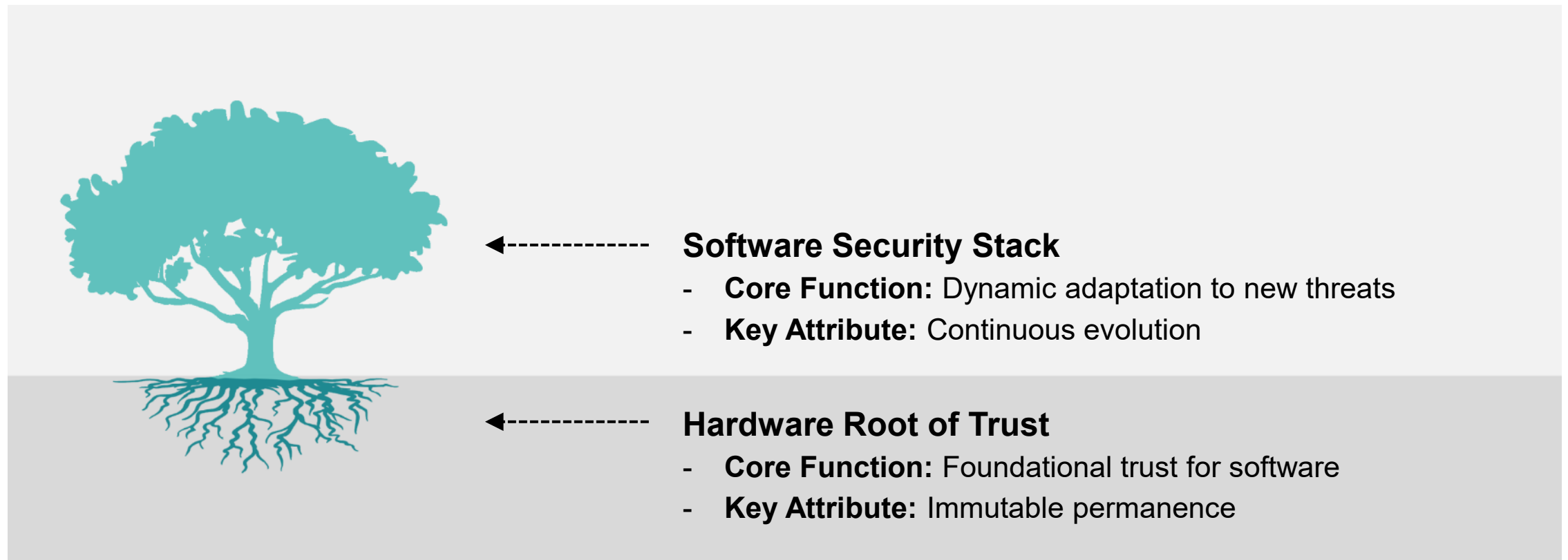

Security Business Development ■

- eMemory drives security IP adoption by collaborating with **leading foundry, processor, and cloud service providers.**

Foundry Platforms



TSMC, Intel, UMC, GF, etc.

- **Technology Licensing:**
Providing security IPs to leading global foundries.
- **Co-marketing Activities:**
Reaching diverse customer bases through joint promotional efforts.

CPU Partners

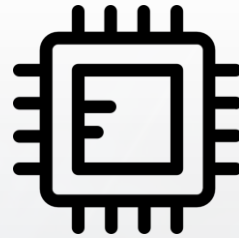

Arm, RISC-V, Cadence, etc.

- **System Integration:**
Addressing SoC customer needs for pre-integrated CPU and security subsystems.
- **Architectural Alignment:**
Collaborating with major processor providers like Arm and RISC-V.

Cloud Service Providers (CSPs)



Microsoft, Meta, Google, Amazon, etc.

- **Hardware-to-Cloud Security:**
Working with CSPs on embedded security requirements at the chip level.
- **Root of Trust Solutions:**
Developing foundational security for systems like AWS, Meta, and Azure.

Standards Drive Hardware-Based Security ■



Driving an open standard for silicon root of trust.



Using asymmetric public/private key encryption technology and device ID to achieve fast and secure access to the network.



Data Center



IoT

Caliptra Open-Source HRoT

- eMemory's **Root of Trust IP** is fully ready to meet the hardware security requirements of the **Caliptra specification**.



Project Start

Sep-21

Caliptra 1.0

Mar-24

Caliptra 2.0 (+PQC)

Oct-24



Caliptra-compliant IPs are designed to be integrated into a wide range of high-performance **Data Center and Edge components**:

- **Compute:** CPUs, GPUs (Accelerators)
- **Storage:** SSD Controllers
- **Networking:** NICs (Network Interface Cards), SmartNICs, DPU
- **Custom Silicon:** ASICs, SoCs

Caliptra HRoT 1.0

» Caliptra HRoT 2.0

eMemory IP Portfolio

OTP

TRNG

PUF

Crypto-processors

Cryptography (PQC)

eMemory

Core Security Capabilities:

- Unique Chip Identity
- Secure Attestation
- Secure Boot

True Random Number Generator (TRNG) .

- eMemory's **PUFtrng** delivers **100x faster performance** and superior entropy quality via PUF-based conditioning algorithms.

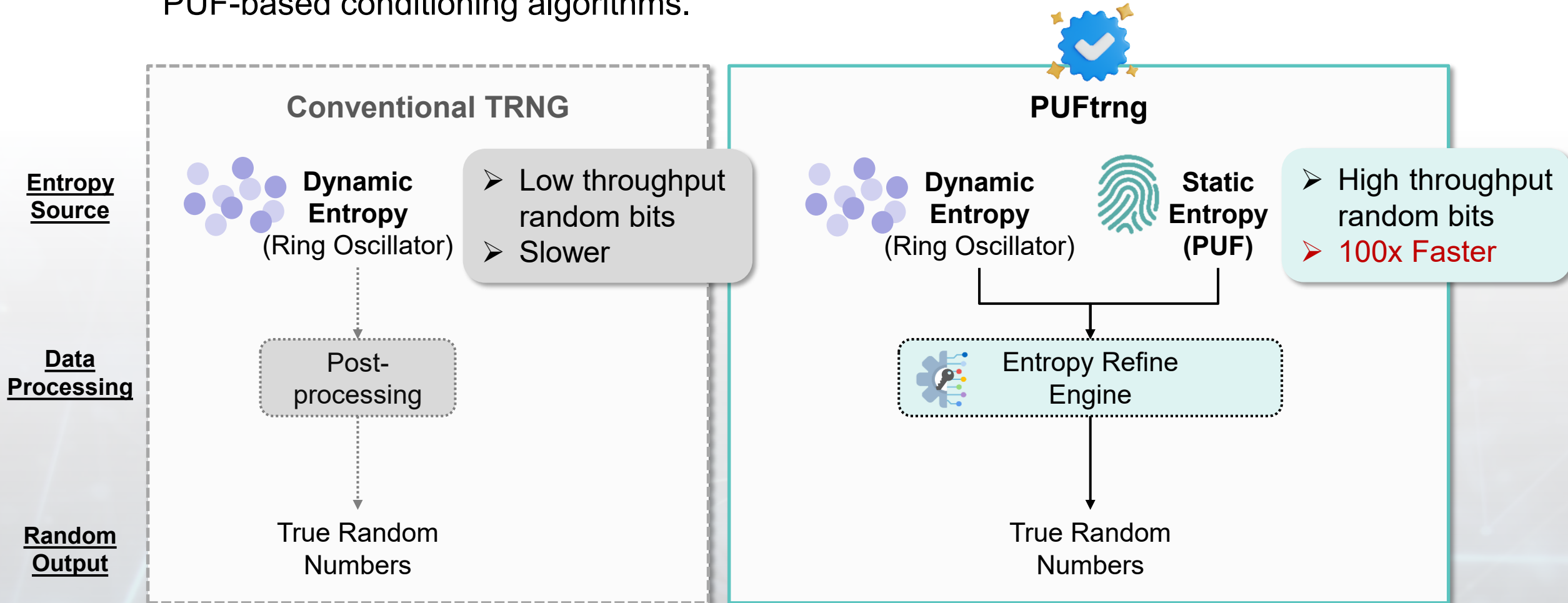

Post-Quantum Cryptography (PQC) ■

- eMemory provides **NIST-compliant hardware foundations** to secure data against future quantum computing threats.



NIST NATIONAL INSTITUTE OF STANDARDS AND TECHNOLOGY
U.S. DEPARTMENT OF COMMERCE

The Open PQC Standardization Project Launched

Dec-16

PQC Migration Factsheet Released

Aug-23

NIST First Set of PQC Algorithms Standardized

Aug-24

Major CSP's 2029 Q-Day Timeline Accelerated

Mar-26



Quantum Threat: Conventional RSA and ECC encryption are vulnerable to future Shor's algorithm attacks by quantum computers.



NIST Standards: Official FIPS 203/204/205 and SP 800-208 define the mandatory PQC baseline for global industries.



eMemory Achievements: Our PUF_{PQC} attains **full NIST coverage**, securing the chain of trust from physical PUF to PQC algorithms.

eMemory for AI Servers and Edge Devices

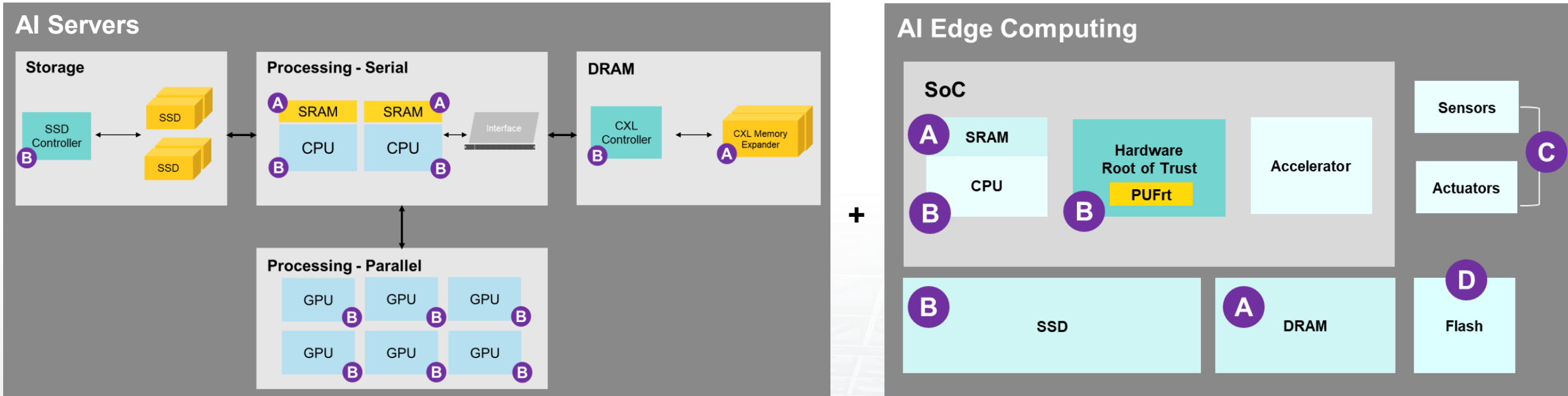

A Memory Repair

- ## B Root of Trust provides:
1. Key storage/generation
 2. Cryptographic processing to protect AI models, input data and output results
 3. Confidential Computing

- ## C OTP needed for trimming analog circuits in Sensors and Actuators

- ## D NeoFlash to replace conventional eFlash for a much lower cost

eMemory enables High-Yielding SRAM

- eMemory's OTP enables high-density SRAM Repair, addressing scaling challenges at advanced nodes.

① Obtains location of bad memory cell

② Stores location of bad memory cell

Stored in **eMemory OTP / eFuse**

③ Takes redundant memory column to replace column with bad cell

X : Bad Cell

④ Replace and "switch" with bad memory cell

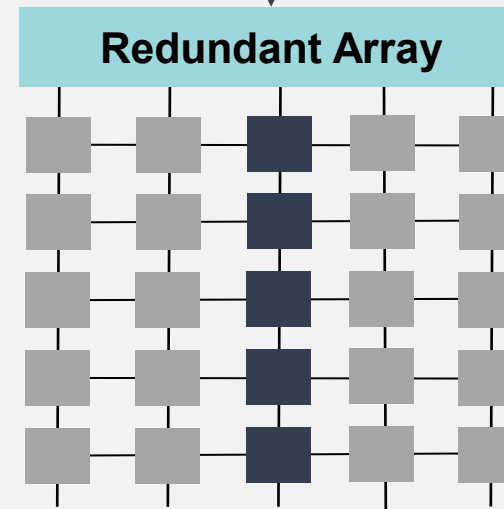
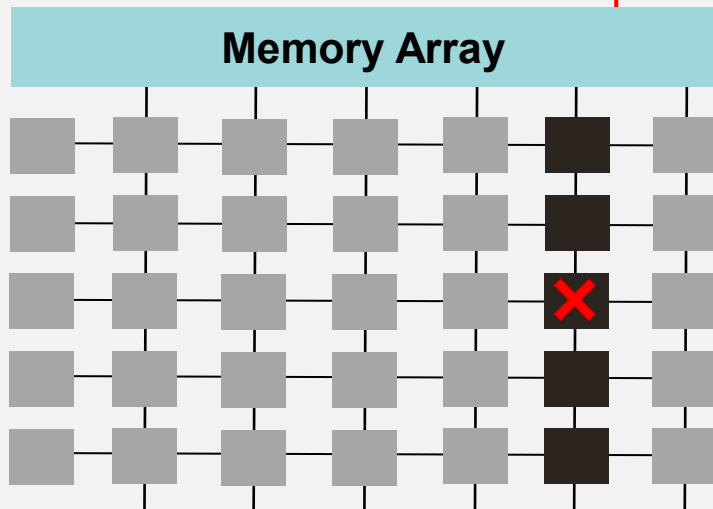

Smaller OTP size
compared to eFuse:

eFuse

NeoFuse

4Kb !

<0.1mm²

64Kb

>1mm² !

64Kb ✓

~0.1mm² ✓

Repair needs **16~256Kb** OTP!

eMemory and Siemens: Partnering for Success

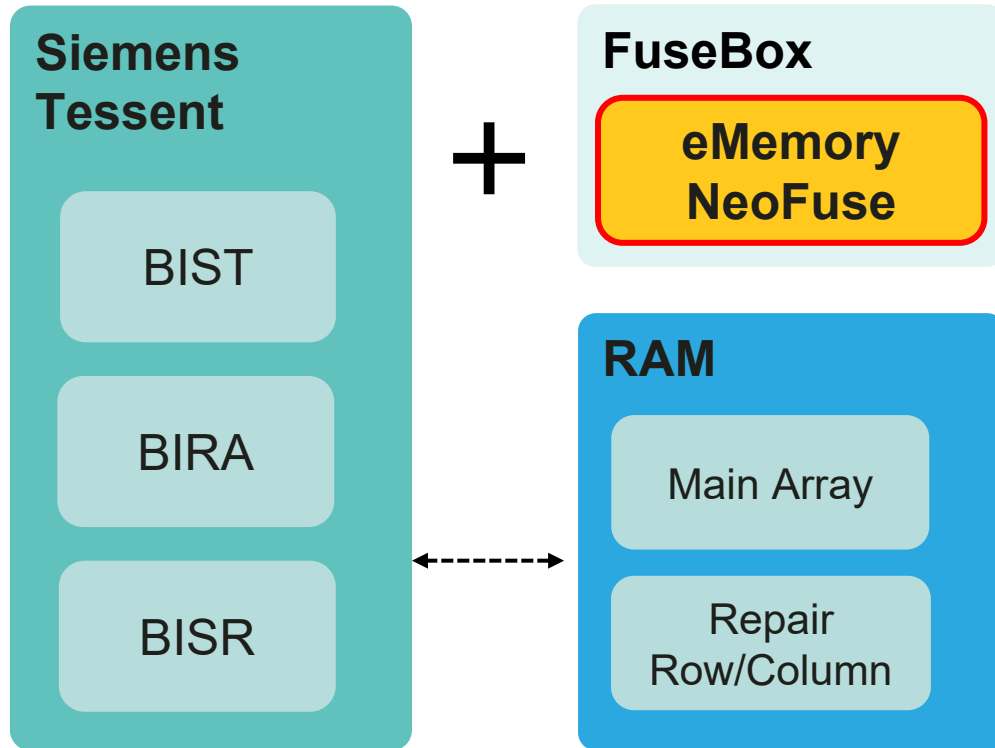

BIST = Built-in Self Test

BIRA = Built-In Redundancy Analysis

BISR = Memory Built-in Self Repair

eMemory provides OTP with interface for Siemens MBIST:

- **Tessent** provides memory BISR functions with BIST and BIRA
- **NeoFuse OTP** provides defect-free OTP using BIRA, BISR and adapter to Tessent
- **New MBISR**: Tessent MBISR + NeoFuse, scanning defective SRAM by word/column and logging to the OTP



1. **Compact**
2. **Flexible**
3. **Robust**

NeoPUF-based HSM Edge Server

- eMemory embeds a physical unclonable root to secure hardware security module (HSM) infrastructure against hardware tampering and insider threats.

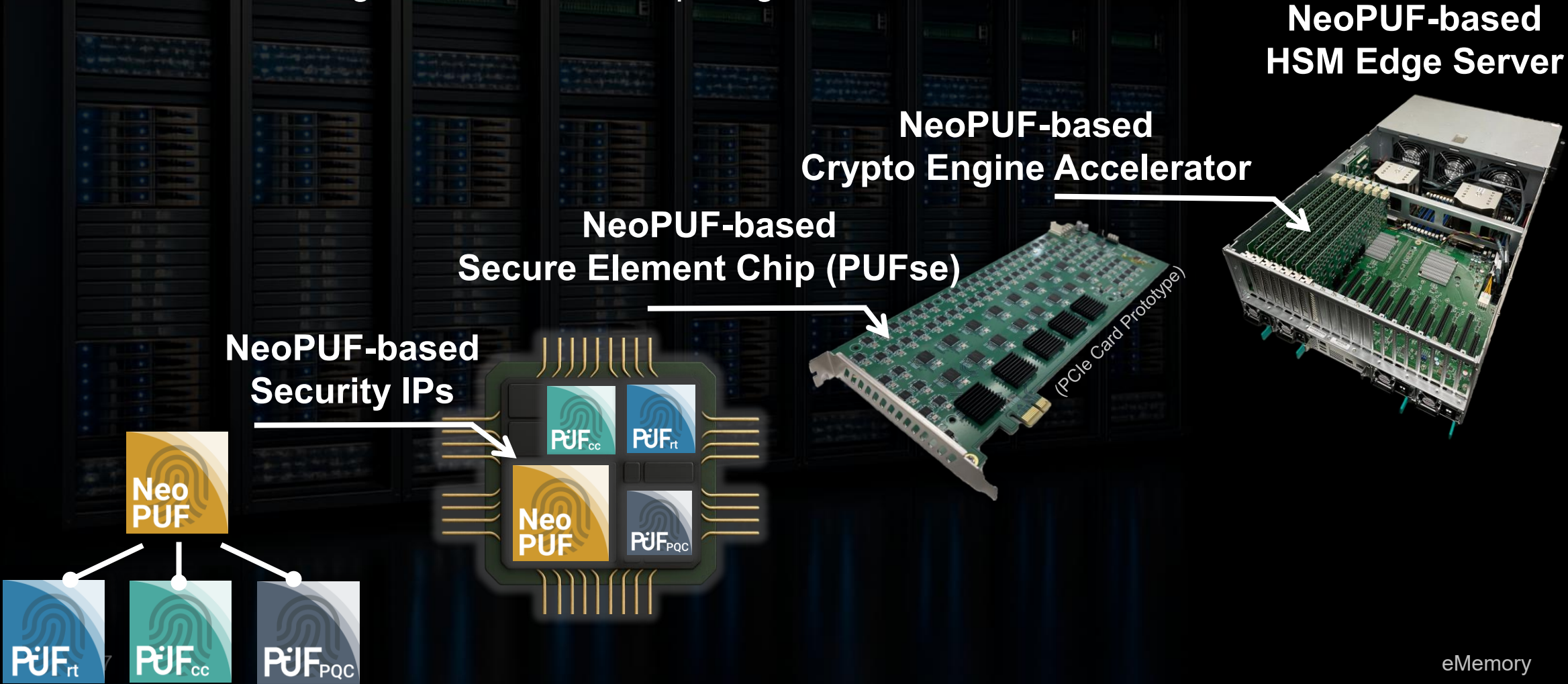

NeoPUF-Based Hardware Security as a Service

- eMemory extends the physical root of trust to software platforms, enabling automated security provisioning for service workflows.

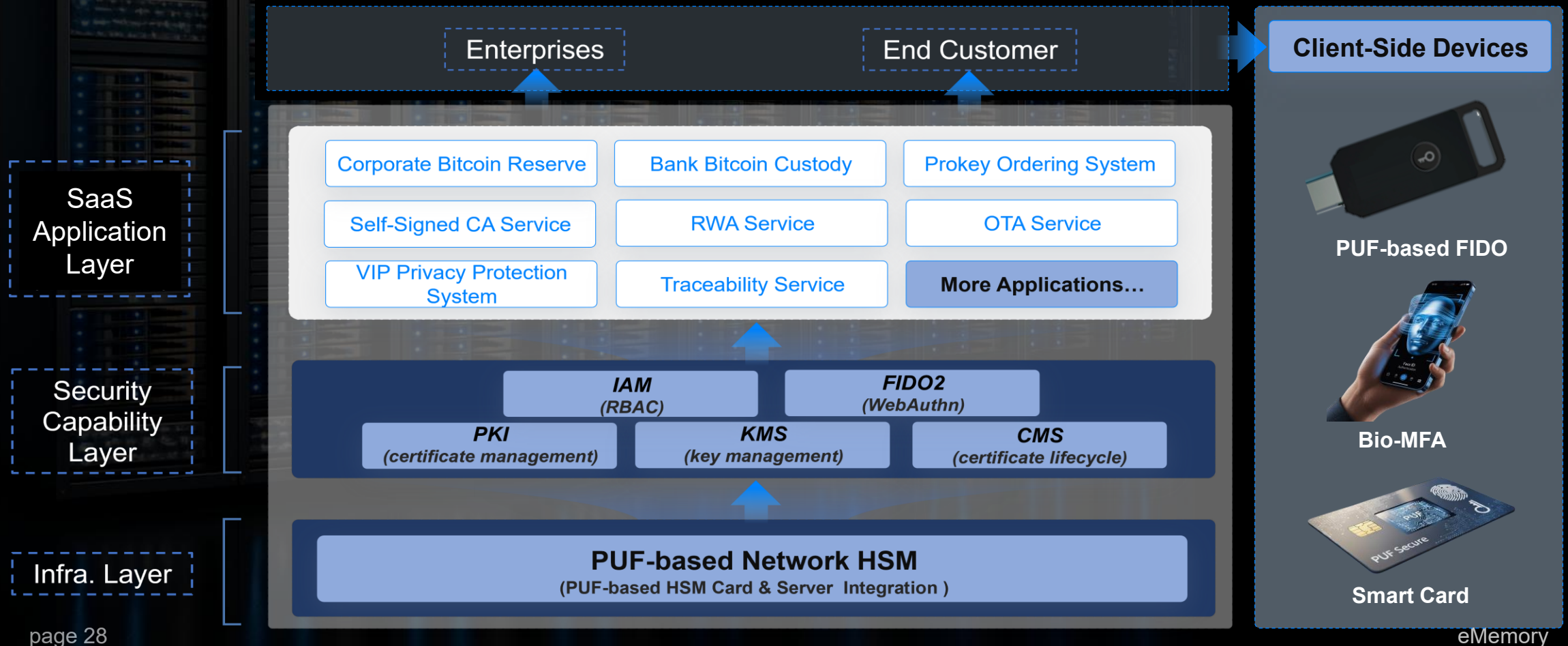

NeoPUF Safeguards National Security

- eMemory establishes a non-replicable hardware identity to protect mission-critical defense supply chains.

A close-up image of a microchip with a central square labeled 'PUF' in white text on a dark blue background. The chip is surrounded by intricate circuitry and pins.

» Create a unique and unclonable hardware identity for every chip

» Establish a hardware root-of-trust, enabling secure key generation and device authentication

» Transform drones, radios, and satellites into trusted and traceable elements of the mission system

NeoPUF Authenticates Defense Applications

- eMemory deploys multi-level hardware security to ensure operational integrity from devices to global supply chains.



Supply Chain Level

Supply Chain Level: Enforces Global Traceability

- Anti-Counterfeiting for Military Electronics
- Supply Chain Security

System Level

System Level: Guarantees Operational Integrity

- Secure Boot & Firmware Integrity
- IoT & Sensor Network Security

Device Level

Device Level: Establishes Hardware Root-of-Trust

- Device Authentication & Identification
- Secure Key Generation

eMemory Video Insight: Security in Action ■

Click on the image to watch the video.

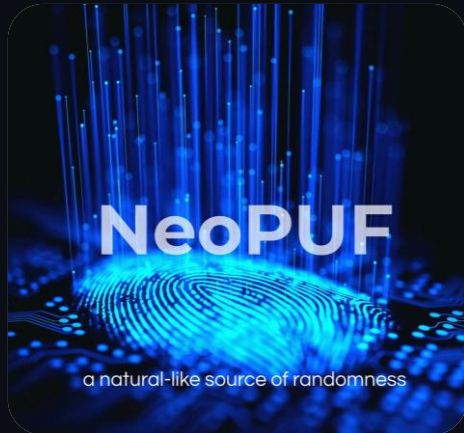

NeoPUF – The Holy Grail of Security

Establishing an unforgeable identity for every chip, creating the ultimate foundation for zero-trust security.

Click on the image to watch the video.



Quantum-Proof Security: PUF based HSM Edge Server for PQC Migration

Transforming hardware security into a scalable service, protecting critical data and infrastructure from cloud to edge.

Click on the image to watch the video.

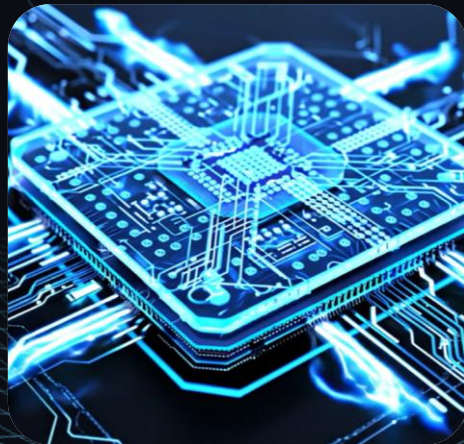

Chiplet Supply Chain Secured by NeoPUF

Extending trust boundaries to secure the future of heterogeneous computing and integration.

Click on the image to watch the video.



NeoPUF: The Hardware Trust Anchor Powering Tomorrow's Defense Systems

Powering the trusted core of next-generation defense security.

Thank You for your time ■

For more information, please visit:

eMemory Website: <https://www.ememory.com.tw/>

PUFsecurity Website: <https://www.pufsecurity.com/>

The logo for eMemory, featuring the word "eMemory" in a white, lowercase, sans-serif font. The background of the slide is a blurred image of a circuit board with various components and traces.